

# Data Sheet



Article number: 23052047110

Description: E+G Handwheel  
EMW.350+IR-A20-C0

## Measures

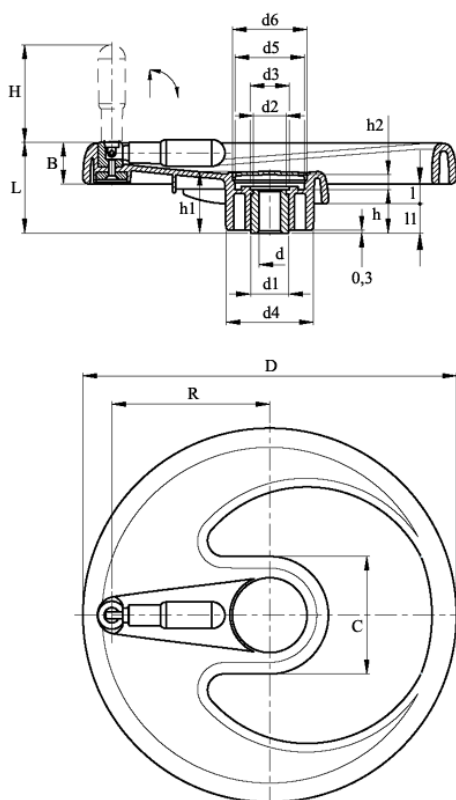

B = 38	d6 = 70	l1 = 25
C = 108	d H7 = 20	R = 148
D = 350	H = 90	
d1 = 35	h = 38	
d2 = 33	h1 = 55	
d3 = 35	h2 = 14	
d4 = 82	l = 19	
d5 = 69	L = 82	